



Dehler

34

Dehler 
34

VALUES

A TRUE DEHLER

Eine Yacht – wie die Dehler 34 – kann man nur bauen, wenn man durch und durch Segler ist. Nur wer sein Leben diesem wunderbaren Sport gewidmet hat, bleibt seinen eigenen Werten treu – und entwickelt jede Yacht mit derselben Hingabe, Innovationskraft und Präzision. Wir bei Dehler machen das so seit über 50 Jahren.

To build a yacht like the Dehler 34, you have to be a sailor through and through. Only those who dedicate their life to this wonderful sport will always stay true to their values and develop each yacht with equal commitment, innovative power and precision. At Dehler, we have been doing this for more than 50 years.



VALUES

PERFECTION IS BASED ON EXPERIENCE

Ein neues Dehler Modell ist erst vollendet, wenn es nichts mehr zu optimieren gibt. Bis dahin fließt unsere ganze Erfahrung aus Jahrzehnten Konstruktionsarbeit, tausenden Yachten und kontinuierlichen Innovationen in die Entwicklung mit ein.

The creating process of a new Dehler model is only completed once there is nothing left to improve. Up to this point, all the experience we gained from decades of design work, thousands of yachts and continuous innovations are incorporated into the development.

25,434 YACHTS

have been delivered by Dehler since 1963 – an experience that results in excellence.

859 INNOVATIONS

that made sailing and living on board significantly more enjoyable were invented by Dehler.

64 MODELS

in all sizes up to 60 feet were created by our designers and developers.

MORE THAN 50 YEARS

of yacht building have continuously increased the demands we place on ourselves and made us one of the leading sailing boat manufacturers.

1 PROMISE

follows from all we achieved until today:
To build the one Dehler 34 you wish for.



VALUES

DEHLER 34

FULL OF IDEAS

MORE SPEED

- | Maximised sail area
- | judel/vrolijk & co designed performance hull
- | Light-weight construction
- | Competition options available

PERFECT QUALITY

- | Full sandwich hull
- | Durable & reliable materials installed
- | Hand-laid teak deck with vacuum bonded wood

HIGHEST SAFETY

- | High righting moment
- | Dehler hull/deck joint
- | Dehler Carbon Cage

INTELLIGENT FUNCTIONALITY

- | Steering pedestal
- | Mainsheet traveller
- | Dehler Uni Door Concept

OUTSTANDING DESIGN

- | Distinctive window line
- | Sleek and elegant profile

BEST RESALE VALUE

- | Made in Germany
- | Timeless elegance
- | Global customer support

STRONG INNOVATIONS

- | Carbon reinforcement in the bottom structure
- | German Mainsheet System
- | Plotter pods designed for optimum ergonomics
- | Recessed cockpit seats



OUR VALUES

In unserem Streben nach der idealen Yacht lassen wir uns von drei klaren Werten leiten. Diese Werte haben uns einst zu den Pionieren im deutschen GFK-Bootsbau gemacht – und sie stecken noch heute in jeder Dehler, die unsere Werft verlässt.

Our passion for creating the perfect yacht is based on three clear values. These values made us a pioneer in German GRP boat building and can be found today in every Dehler leaving our shipyard.



Value No. 1

PROCEED WITH SPEED

Für uns gehört Segelleistung zu den wichtigsten Tugenden einer Yacht. Warum? Weil es immer wieder begeistert die Kraft zu spüren, mit der der Bug rasant die Wellen durchschneidet. Und um Begeisterung geht es beim Segeln nun einmal. Deshalb haben auch unsere komfortablen Yachten immer Sport-Genie.

For us, sailing performance is one of a yacht's most important qualities. Why? Because it is incredible fun to feel the force the bow exerts when cutting through the waves at a terrific pace; and sailing is simply about having fun. That's why our comfortable yachts have always sports in their DNA, too.

Value No. 2

SMART PERFECTION

Eine perfekte Yacht ist schnell, sicher und schön. Die Ausstattung lässt keine Wünsche offen. Im Design verschmilzt Funktion mit Ästhetik und die Verarbeitung ist makellos bis ins kleinste Detail. Diesen hohen Ansprüchen fühlen wir uns bei Dehler täglich verpflichtet. Wir bauen jede Yacht so, dass Sie beeindruckt sind von den vielen cleveren Ideen. Wenn alle Lösungen ganz einfach aussehen, obwohl es harte Arbeit war, dann ist es „Smart Perfection“.

A perfect yacht is fast, safe and beautiful. Its features meet any desire a sailor might ever have. Its design blends functionality with aesthetics, and the workmanship is flawless, right down to the smallest detail. These are the high standards we are committed to, striving to meet them every day. We build each yacht in such a way that you will be impressed by lots of clever ideas. 'Smart Perfection' is when solutions seem really simple although hard work has been put into them.

Value No. 3

GERMAN ENGINEERING

Dehler steht für die Werte, die „Made in Germany“ zu dem Gütesiegel gemacht haben, das es bis heute ist. Vor allem zählt für uns Gründlichkeit. Präzision in jedem Detail prägt unser Denken und Handeln sowie die Wahl unserer Partner. Dazu gehören vor allem die international renommierten Yacht-Konstrukteure judel/vrolijk & co. Sichtbar wird dies in zeitlosen Formen mit dynamisch-eleganten Linien.

Dehler justifies values that turned 'Made in Germany' into the seal of approval that it is today. Thoroughness counts before everything else. Precision in every detail is what shapes the way we think and act as well as who we choose to be our partners. Most notably, the internationally renowned yacht designers judel/vrolijk & co belong to our partners. Timeless shapes with dynamic, elegant lines are testimony to all of this.



DEHLER 34

CONTENT

INHALT

VALUES

2 A TRUE DEHLER

4 PERFECTION IS BASED ON EXPERIENCE

6 DEHLER 34 FULL OF IDEAS

8 OUR VALUES

INDIVIDUALITY

13 IT'S UP TO YOU

14 EASY TO SAIL

15 HARD TO BEAT

16 COMPETITION & CRUISING STYLE

60 PACKAGES

62 OPTIONS

EXTERIOR

20 DECK

28 TECHNICAL SPECIFICATIONS

32 MATERIALS & COLOURS

INTERIOR

40 SALOON & PANTRY

42 HEAD

44 CABIN LAYOUTS

46 MATERIALS & COLOURS

TECHNOLOGY

25 CARBON RIG

26 DEHLER FREERIDE

54 DEEPER INSIDE

58 SAFETY CLOUD



”

Following the new established design lines, the Dehler 34 offers a well-balanced ratio between cruising comfort and swift performance. The new window line identifies it as a Dehler even from a far distance. The true strength lies in its versatility. See it as an upgrade from a perfectly equipped cruiser to an outstandingly fast competitor or vice versa. The Dehler 34 is the perfect platform to enjoy every sailing style to the fullest.

Torsten Conradi, Managing Director of judel/vrolijk & co



Dehler FREERIDE: for speedy sailing in light winds.

INDIVIDUALITY

IT'S UP TO YOU

Die Dehler 34 ist wandelbar, wie ein Chamäleon. Fahrtenschiff, Performance-Cruiser, Regatta-Yacht: Ihre Fahrleistungen lassen sich nach Belieben steigern und passen sich Ihrem Segelstil an. Auch unter Deck stehen Ihnen alle Möglichkeiten offen. Hier löst eine Vielfalt an Kabinenlayouts und Materialien unser Versprechen ein: Die Dehler ist immer das, was Sie daraus machen.

The Dehler 34 is as changeable as a chameleon. Touring yacht, performance cruiser, regatta racer – her speed performance can be increased as you like and adapts completely to your personal sailing style. Even below deck, all options are open. Offering a huge variety of cabin layouts and materials, we keep our promise: The Dehler is whatever you make it.



First choice for speedy sailing: **the carbon rig.**



High quality **vacuum bonded teak deck.**



Stylish and custom made: the interior of your Dehler 34.

INDIVIDUALITY

EASY TO SAIL

Höchster Segelkomfort gehört bei einer Dehler zur Gundausrüstung. Bestes Beispiel: das German Mainsheet System. Die beiden Enden der Großschot werden auf getrennte Winschen gelegt. So haben Sie die Schot auf beiden Cockpitseiten in unmittelbarer Reichweite. Ohne Ihren Steuerstand zu verlassen, behalten Sie volle Kontrolle über das Segel.

On a Dehler, great sailing comfort is part of the basic equipment. It comes, for example, with the German Mainsheet System: both ends of the mainsheet are taken to separate winches. Now the line is within immediate reach on each side of the cockpit. You will always maintain full control of the mainsail without leaving the helm.



HARD TO BEAT

Ein paar Modifikationen genügen, und schon wird aus dem komfortablen Performance-Cruiser eine reinrassige Regatta-Yacht. Für kleine und große Crews, für die All-day-Wettfahrt mit Freunden und Steg-Nachbarn, für die Regatta mit internationalem Feld – oder einfach nur für Ihren ganz privaten sportlichen Ehrgeiz. Viel Spaß.

Just a few modifications and your luxurious performance cruiser will be turned into a pure regatta yacht. For smaller and bigger crews, for the all-day-races with friends and jetty neighbours – or simply for your very private sporty ambitions. Have fun.

COMPETITION STYLE

- A** **TP6 SAILS**
lighter and more stable with a longer life span
- B** **CARBON RIG**
reduced weight compared to standard aluminium rig
- C** **ANTI-SLIP SURFACE**
for light weight and safe sailing
- D** **BOW SPRIT**
increases sailing performance with asymmetrical headsails
- E** **COMPETITION RUDDER**
deeper and thinner construction
- F** **TILLER STEERING**
perfect for competitive sailing
- G** **COMPETITION STYLE COVELINE**
a tribute to the legendary model history
- H** **COMPETITION RAILING**
light weight reinforced competition railing
- I** **INSTRUMENTS CONSOLE**
2x B&G multifunction displays, Zeus³ 7 GPS chart plotter
- J** **COMPETITION KEEL**
maximum ballast concentrated at led bulb

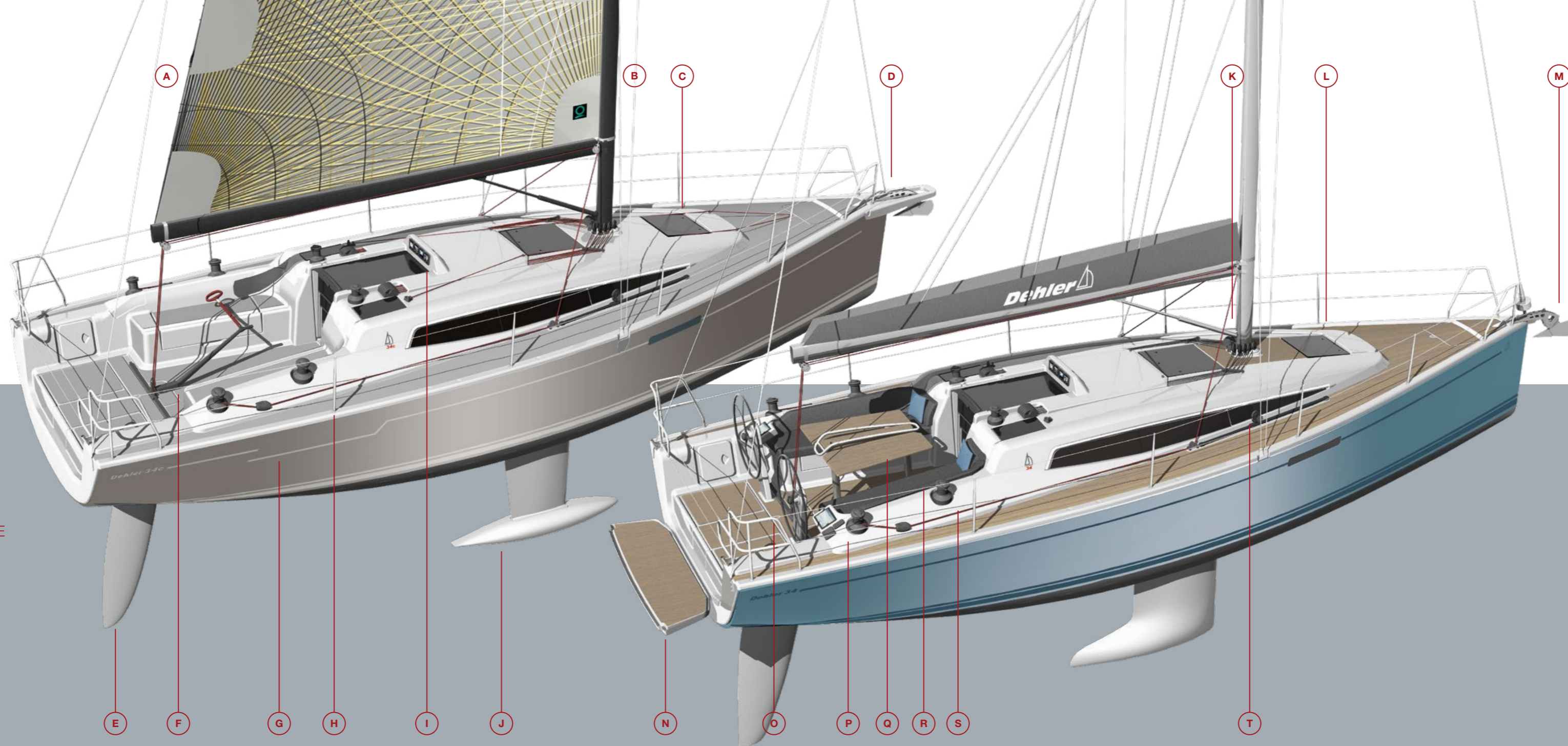

CRUISING STYLE

- K** **GERMAN MAINSHEET SYSTEM**
mainsheet control from both helmsman positions
- L** **TWO LARGE FLUSH HATCHES**
for optimum ventilation
- M** **S/S ANCHOR FITTING**
with chain up to 50 m
- N** **BATHING PLATFORM**
with convenient swimming ladder
- O** **Y-SPOKE TWIN STEERING WHEEL**
for more comfortable helming
- P** **PLOTTER CONSOLES**
2x B&G Zeus³ 7 GPS ergonomic chart plotter on each console
- Q** **COCKPIT TEAK TABLE**
- R** **CUSTOMISED UPHOLSTERY**
many colours and materials available
- S** **SELF TAILING WINCHES**
for comfortable and easy sailing
- T** **OPENING SIDE WINDOWS**
for optimum ventilation



Dehler 
34

EXTERIOR

CHARACTER THAT MEETS THE EYE

Die Dehler 34 ist vieles: edles Apartment auf See, Hightech-Sportgerät – und dank ihres Designs ein markantes Bekenntnis zum echten, unverfälschten Segeln.

The Dehler 34 is many things: an exquisite apartment at sea, high-tech sport equipment – and due to her design, a distinctive commitment to the unadulterated kind of sailing.





The bathing platform enhances the space on deck.



EXTERIOR

DECK

Auf den ersten Blick fällt das klare, aufgeräumte Design des Decks auf. Alle Winschen, Klampen, Rollen und viele weitere clevere Details sind an der richtigen Stelle und genau so positioniert, dass beim Segeln alles perfekt zur Hand liegt.

The distinct, clean-cut deck design catches your eye at first glance. All the winches, cleats, rollers and many smart details more are positioned just in the right places, so everything will be close at hand.



Anti-slip side deck with genoa tracks adjustable from the cockpit and openable windows for optimum ventilation.



Y-spoke wheels and traveller for perfect sailing.



Navigation instruments can be alternatively placed above the companionway.



Ergonomic plotter pods are positioned behind each steering wheel.



The optional bow sprit increases the sailing performance with asymmetrical headsails.



Being recessed into the floor, the mainsheet traveller allows an ideal trim of the mainsail.

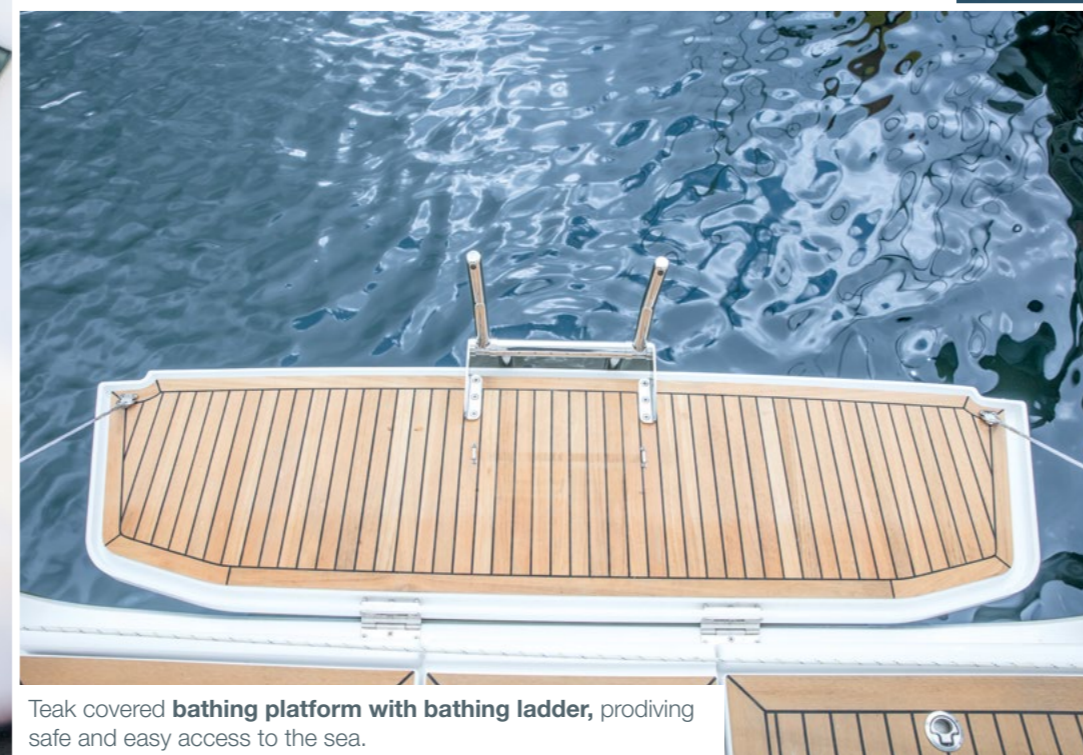

Teak covered bathing platform with bathing ladder, providing safe and easy access to the sea.



Smart solution – the integrated companionway hatch.



The latest Dehler innovation: Recessed cockpit seats give more safety when sailing.

TECHNICAL RIG SPECIFICATIONS

	STANDARD
Weight	145 kg / 320 lbs
Shrouds	1x19
Backstay	one-sided
Spreader	alu
Boom	alu
Boom vang	alu
Main sail sliders	Selden
Total sail area	63.10 m ² / 679 sq ft
I	13.60 m / 44'7"
J	3.87 m / 12'8"
P	13.25 m / 43'6"
E	4.95 m / 16'3"

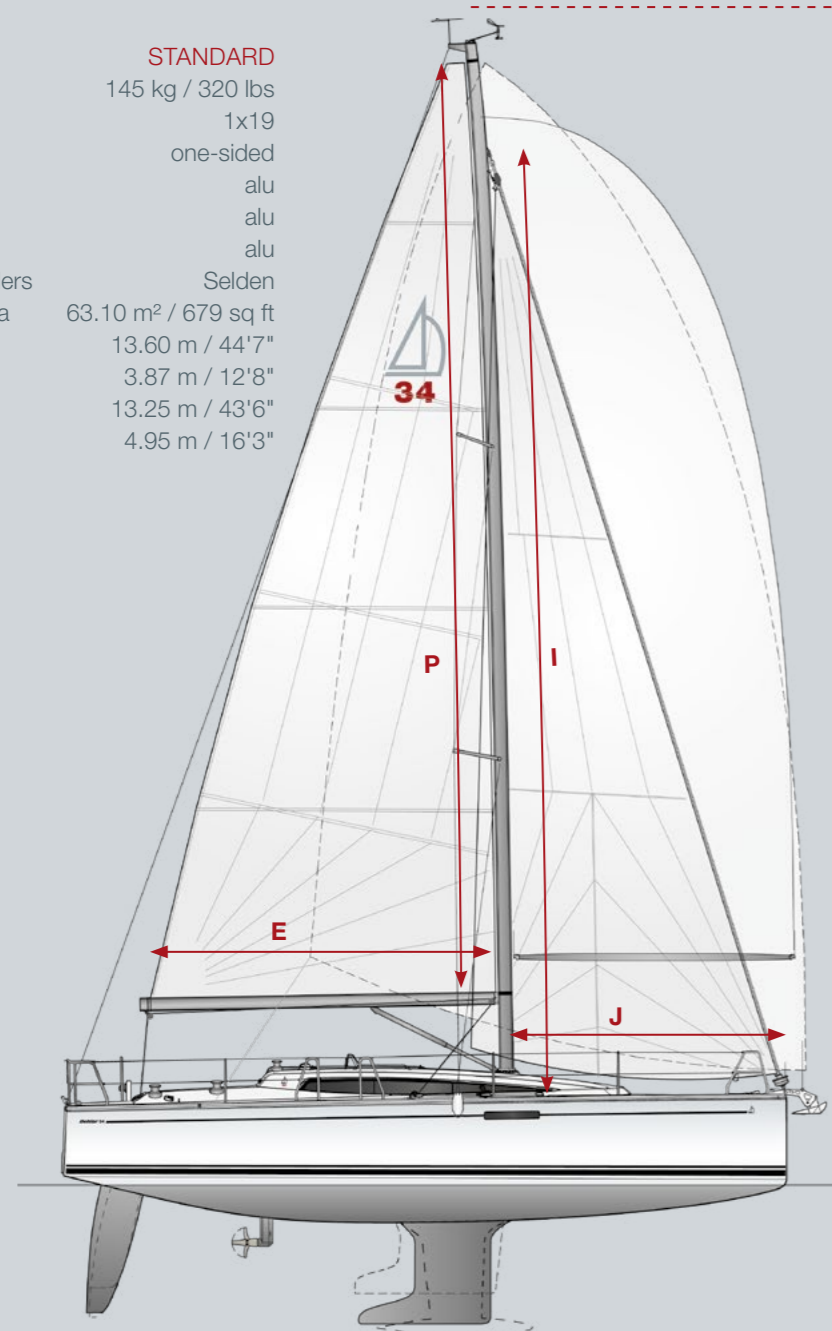

	CARBON RIG
Weight	105 kg / 231 lbs
Shrouds	rod rig
Backstay	double-sided
Spreader	carbon
Boom	carbon
Boom vang	carbon
Main sail sliders	Antal
Total sail area	70.89 m ² / 763 sq ft
I	13.90 m / 45'6"
J	3.87 m / 12'8"
P	14.00 m / 45'9"
E	4.95 m / 16'3"



EXTERIOR

CARBON RIG

Unser Rigg aus dem Hightech-Werkstoff Karbon bringt entscheidende Vorteile: Der Mast ist länger, leichter und steifer als der Standard-Alu-Mast, bietet eine größere Segelfläche – und damit ein Mehr an Segelleistung bei leichtem Wind und bei Seegang.

Our rig made of the high-tech material carbon provides decisive advantages: The mast is longer, lighter and stiffer than the standard alu mast. It enlarges the sail area, which increases the sailing performance in rough seas and light winds.

BOOST YOUR SAIL PERFORMANCE BY 20 S/NM

When equipped with TP6 sails and carbon rig, competition rudder and deep keel, your Dehler 34 can sail significantly faster:

ALU RIG		CARBON RIG	
at 16 kn true wind		at 16 kn true wind	
45°	7.0 kn	45°	7.1 kn
60°	7.5 kn	60°	7.6 kn
90°	7.9 kn	90°	8.1 kn
120°	8.3 kn	120°	8.5 kn
135°	7.9 kn	135°	8.1 kn

As a result the yacht is approx. **20 s/nm faster**, achieving an ORC value of **GPH 633 s/nm**.

SAIL PERFORMANCE

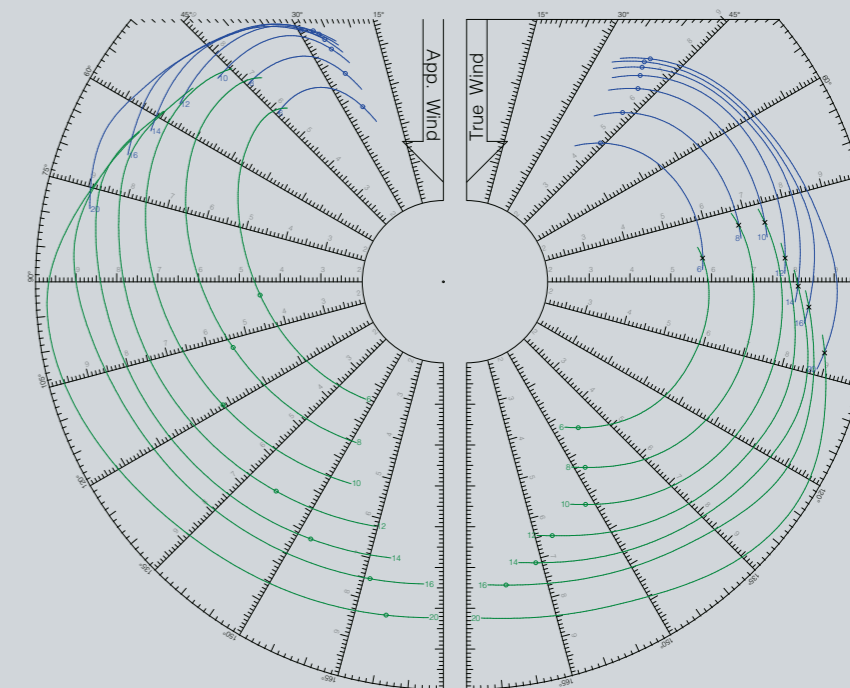



NEW!

DEHLER FREERIDE

Das neue Dehler FREERIDE besitzt die perfekte Segelgröße zwischen Genua und Gennaker und hat den größten Windeinsatzbereich seiner Klasse. Das heißt: Vom Am-Wind-Kurs bis zum tiefen Raumkurs bringt das FREERIDE Ihre Dehler auf Geschwindigkeit.

Dabei ist es ein voll einhandaugliches Segel. Es wird aus dem speziell entwickelten Sailbag vom Deck gesetzt. Mit zwei Klicks wird es am Ankerbeschlag und Gennakerfall befestigt und kann eingerollt als zweites Vorstag im Hafen gesetzt bleiben. Gefahren wird das Dehler FREERIDE mit den Gennakerschoten über eine beliebige Winsch im Cockpit.

The new Dehler FREERIDE is the perfect intermediate size between genoa and gennaker, offering the largest wind range in its class. That means, the FREERIDE speeds up your Dehler, no matter if you are sailing a close reach or broad reach course.

Fully optimised for single-handed sailing, it is set out of the specially designed sailbag at deck level. Attaching it to the anchor bracket and gennaker halyard takes two simple clicks. The rolled-up sail can remain set as second forestay in the marina. It is operated with the gennaker sheets using any winch in the cockpit.

DEHLER FREERIDE

- | Up to 73.28 m² sail area, for wind speeds starting at 5 kn
- | Made of CZ laminate with trioptimal cut – a very lightweight black material containing Twaron high-performance fibres and black Technora X – Ply
- | Quickly fixed with just two clicks and rolled out
- | High-grade furling system and special furling cable included
- | Specially developed weatherproof sailbag

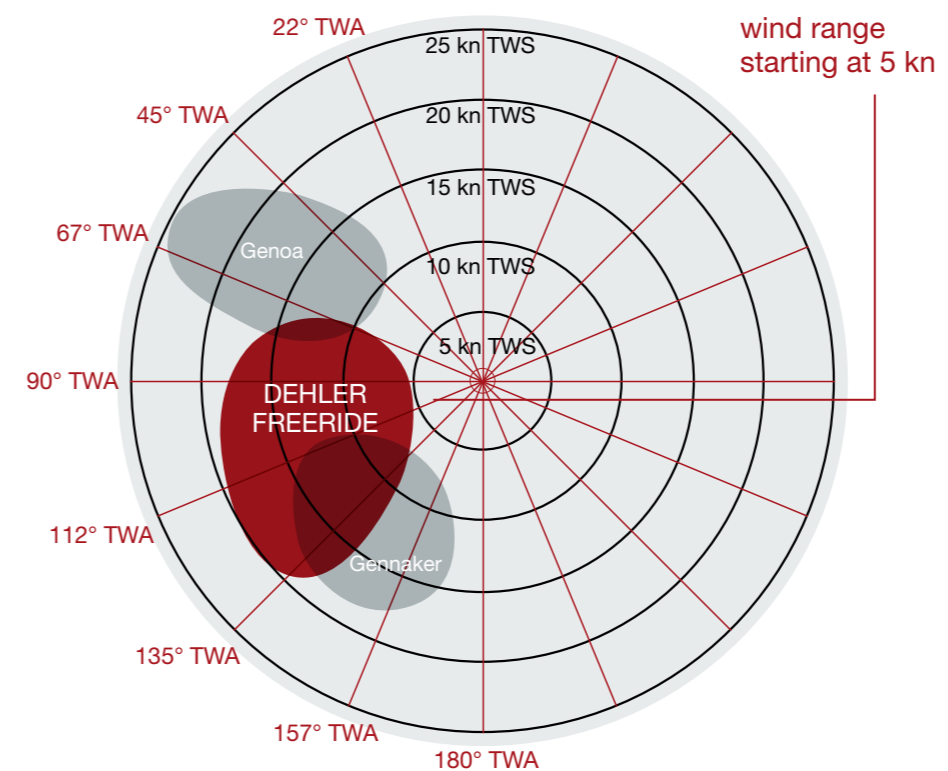

Dehler FREERIDE:
Standard: 65.32 m²
Competition: 73.28 m²

— UV-protected

— integrated
torsion cable
and endless
furling system

PERFORMANCE SAILS

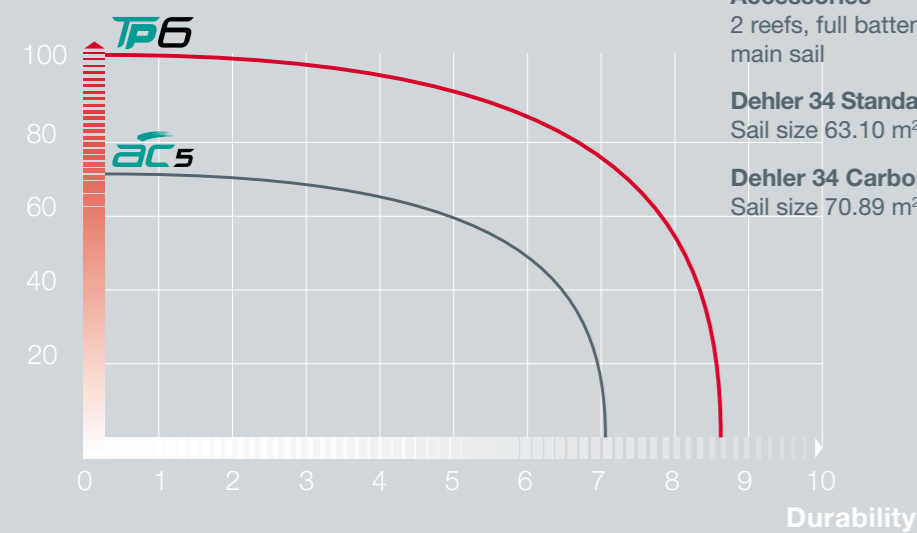

Layout / Cloth

TP6
Top Performance Sails

Accessories
2 reefs, full batten
main sail

Dehler 34 Standard Rig
Sail size 63.10 m²

Dehler 34 Carbon Rig
Sail size 70.89 m²

EXTERIOR

TECHNICAL SPECIFICATIONS

Mit unseren vielfältigen Ausstattungsoptionen können Sie Ihre Dehler auf Ihr Segelrevier und Ihre Art zu segeln abstimmen. Wählen Sie aus drei Kielarten – von der Flachwasser- bis zur Performance-Version mit extrem tiefem Schwerpunkt. Wünschen Sie es noch sportlicher, nehmen Sie das Carbon- anstelle des Aluminium-Riggs. Für die optimale Geschwindigkeit bei tieferen Kursen bietet Ihnen die Dehler 34 die Möglichkeit, gleich drei verschiedene Segel einzusetzen.

Thanks to our diverse range of configuration options, you can perfectly adapt your Dehler to your yachting waters and manner of sailing. Choose from three keel types: from shallow water to a performance version with an extremely low centre of gravity. If you want it even sportier, opt for the carbon rig instead of aluminium. When it comes to achieving optimal speeds with downwind courses, your Dehler 34 lets you select from three different sails.

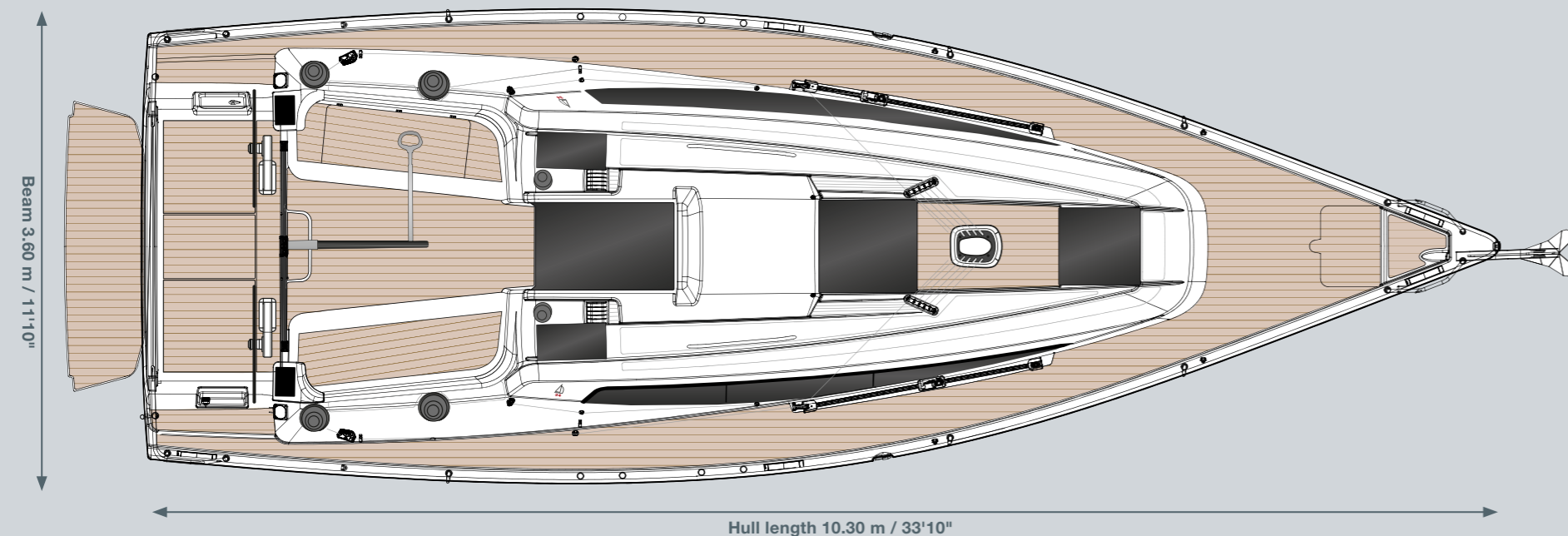

TECHNICAL SPECIFICATIONS

HULL

LOA	10.70 m / 35'1"
Hull length	10.30 m / 33'10"
LWL	9.60 m / 31'6"
Beam	3.60 m / 11'10"

DRAUGHT

Standard	1.95 m / 6'5"
Competition	2.10 m / 6'11"
Shallow	1.55 m / 5'1"

DISPLACEMENT

Standard	6.00 t / 13,227 lbs
Competition	5.60 t / 12,345 lbs
Deep Keel	6.10 t / 13,448 lbs

BALLAST

Standard	2.10 t / 4,630 lbs
Competition	1.70 t / 3,747 lbs
Shallow	2.25 t / 4,960 lbs

ENGINE (APPROX.)

Diesel	21 PS / hp
--------	------------

TANKS

Fresh Water	210 l / 55.48 gal
Fuel Tank	160 l / 42.27 gal

HULL DESIGN

judel/vrolijk & co

INTERIOR DESIGN

Dehler

CE CERTIFICATE

A - 4

RIG

Mast length above WL	
Standard	16.27 m / 53'5"
Competition	17.02 m / 55'8"

Standard	Competition
I 13.60 m / 44'7"	I 13.90 m / 45'6"
J 3.87 m / 12'8"	J 3.87 m / 12'8"
P 13.25 m / 43'6"	P 14.00 m / 45'9"
E 4.95 m / 16'3"	E 4.95 m / 16'3"

MAINSAIL

Standard	Competition
37.10 m ² / 399 sq ft	41.58 m ² / 448 sq ft

FURLING JIB

Standard (105%)	Competition (105%)
26.00 m ² / 280 sq ft	29.31 m ² / 315 sq ft

TOTAL SAIL AREA

Standard	Competition
63.10 m ² / 679 sq ft	70.89 m ² / 763 sq ft

SPINNAKER

Competition
95.60 m ² / 1,029 sq ft

GENNAKER

Standard	Competition
93.10 m ² / 1,002 sq ft	100.10 m ² / 1,077 sq ft

FREERIDE

Standard	Competition
65.32 m ² / 703 sq ft	73.28 m ² / 789 sq ft

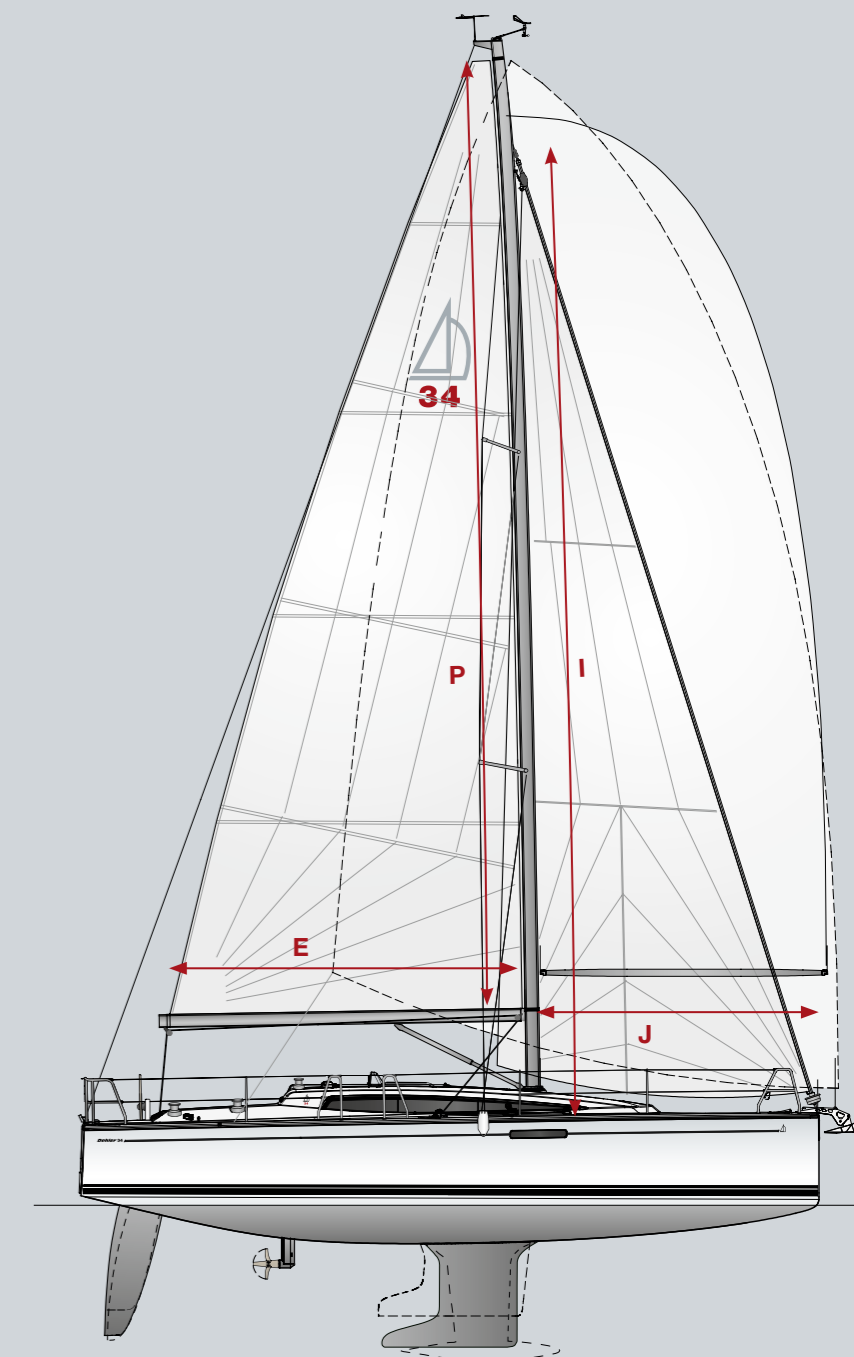





EXTERIOR

MATERIALS & COLOURS

Die Farbe des Rumpfes, der Stil des Teak-Decks:

Erst mit der Gestaltung der Oberflächen verleihen Sie dem Exterieur seinen letzten Schliff.

The colour of the hull, the style of the teak deck:

It is your personal surface design that applies the finishing touches to the exterior.

EXTERIOR | GELCOAT HULL, WATERLINE & COVELINE

EXTERIOR | PAINTED HULL, WATERLINE & COVELINE

The hull, waterline & coveline can be painted in almost every colour (metallic/non metallic) according to the Alexseal Yacht Coatings Selection.

STANDARD

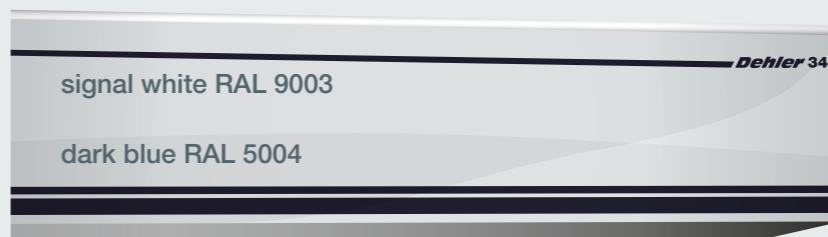

OPTIONS



OPTIONS

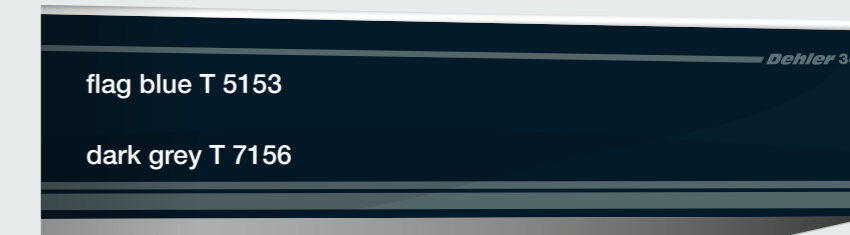
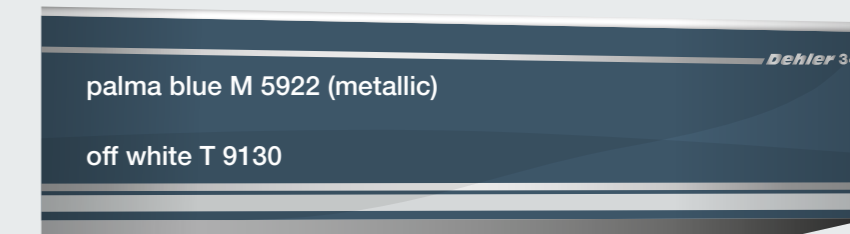
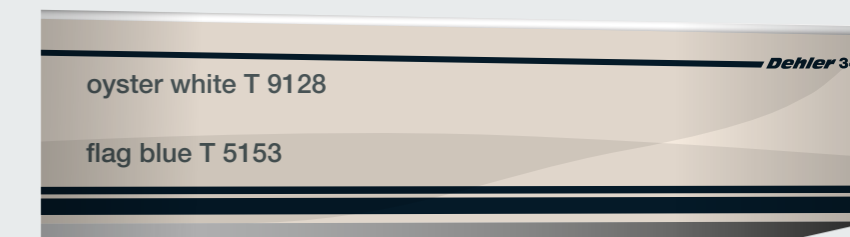

EXTERIOR | COVERS & UPHOLSTERY

Maindrop, Sprayhood, Steering Wheel Cover, Cockpit Table Cover

OPTIONS

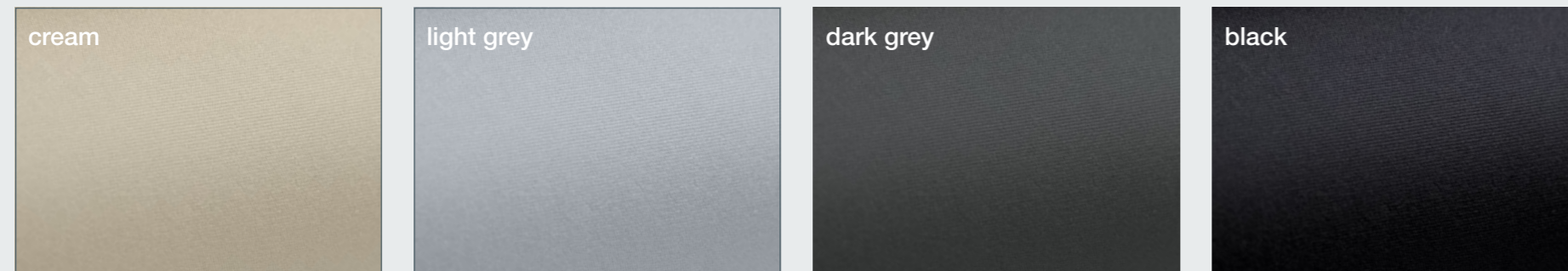

Cockpit Cushions

OPTIONS

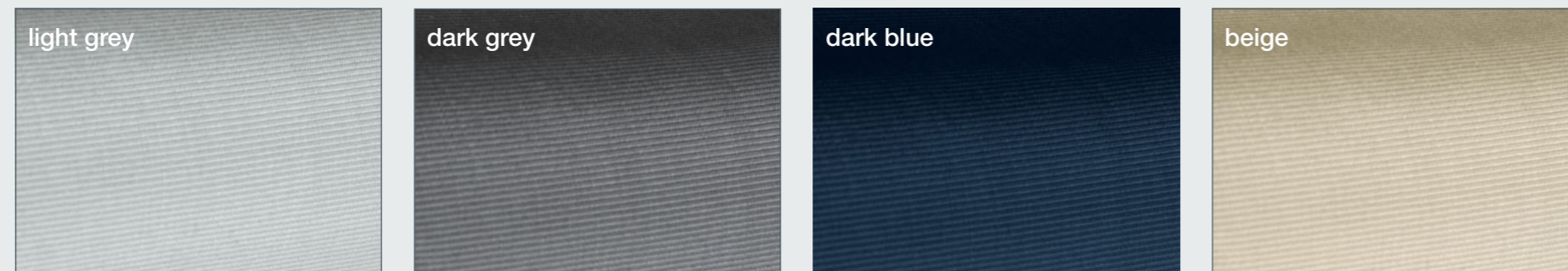

EXTERIOR | NATURAL TEAK & SYNTHETIC TEAK

NATURAL TEAK OPTION

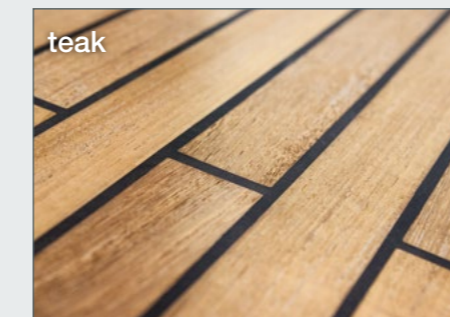

SYNTHETIC TEAK OPTIONS

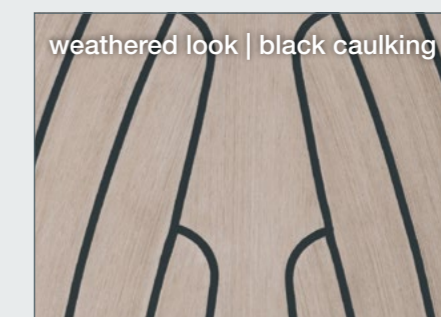
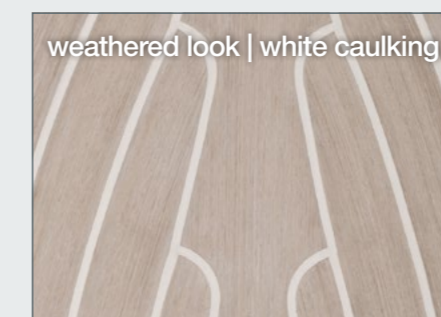
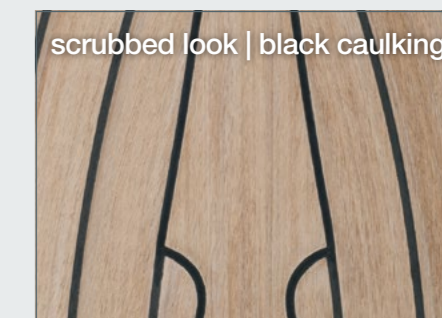
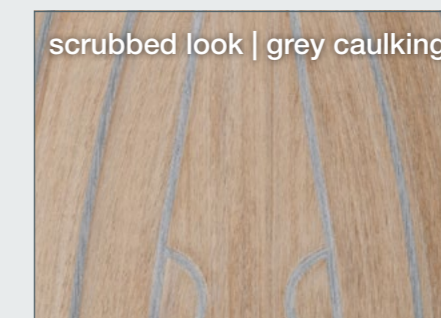
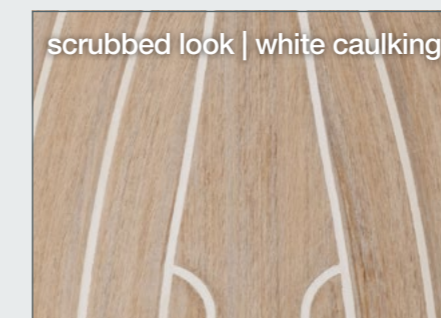



Dehler 
34

INTERIOR

DESIGNED TO MAKE YOU FEEL AT HOME

Machen Sie es sich bequem. Gestalten Sie den harmonischen Innenraum mit seinen elegant fließenden Formen nach Ihren Wünschen.

Make yourself comfortable. Style the harmonious and elegantly shaped interior according to your preferences.





INTERIOR

SALOON & PANTRY

Der zentrale Bereich im Inneren bietet zahlreiche bemerkenswerte Lösungen zur optimalen Raumnutzung. So lassen sich zum Beispiel die Salonschränke mit ihren markanten Rundungen praktischerweise nach oben öffnen.

The central area of the interior provides many remarkable ways of using space efficiently. For example, the saloon cabinets with their distinctive curves open upwards in a practical fashion.



A feast for the eye: gently **rounded shapes** and **superb mahogany** woodwork.

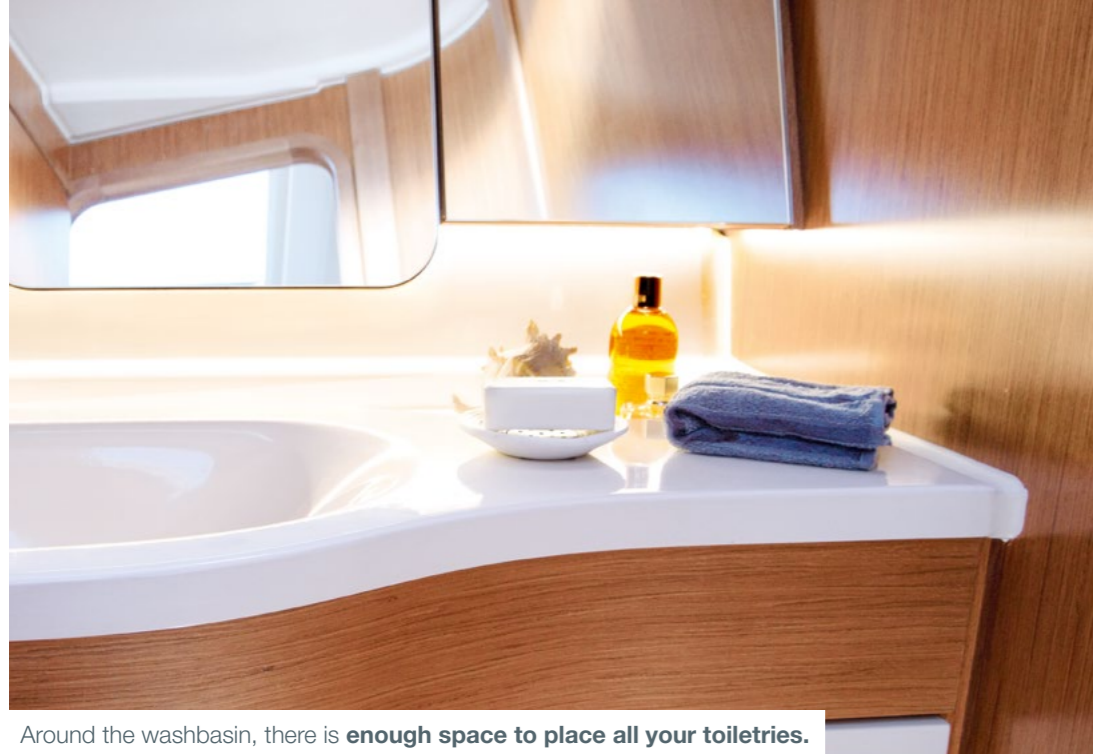

Around the washbasin, there is **enough space to place all your toiletries.**

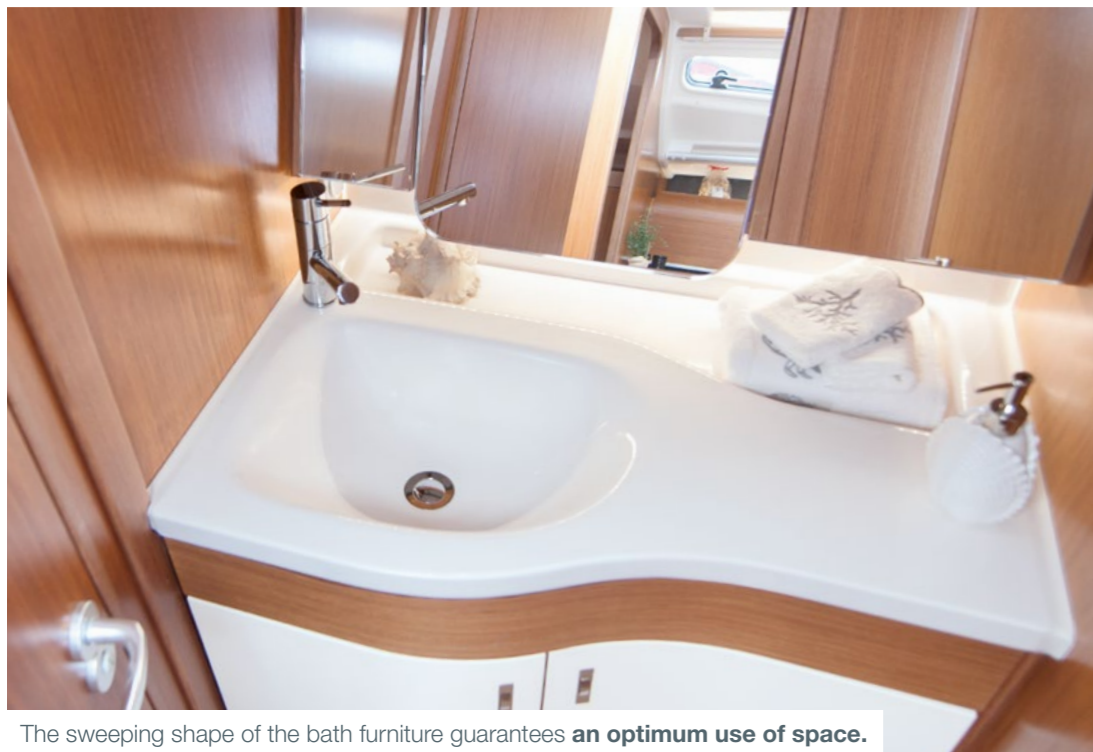

The sweeping shape of the bath furniture guarantees **an optimum use of space.**

INTERIOR

HEAD

Darauf sind wir stolz: Das Dehler Uni Door Concept, das Ihnen stets die Wahl zwischen zwei Raum-Layouts lässt. Der Clou dabei ist eine Tür für zwei Rahmen. Schwingt die Tür zur einen Seite, entsteht ein geräumiges Badezimmer, das vom Salon getrennt ist. Schwingt sie zur anderen, verschließt sie stattdessen den Raum mit Dusche und WC. Gleichzeitig gibt sie den Durchgang vom Waschbereich zum Salon frei, was ein besonders großzügiges Raumgefühl schafft.

We are proud of our Dehler Uni Door Concept, which always gives you a choice between two room layouts. Its key feature is having one door for two frames. The door swings open one way onto a roomy bathroom that is separate from the saloon. When the door swings the other way, it closes the shower and toilet room instead. The hallway from the wash area to the saloon is free at the same time, making the room feel very spacious.

engineered
by **Dehler**

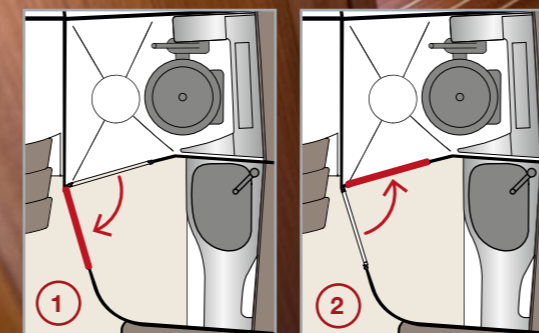

Dehler Uni Door Concept

1. The door swings open one way towards a roomy bathroom that is separate from the saloon.
2. When the door swings the other way, it closes the shower and toilet room instead.





Large bow cabin with double V-berth and cabinet lockers below.



Spacious aft cabin incl. locker on starboard.



INTERIOR

CABIN LAYOUTS

In der Standard-Version verfügt die Dehler 34 über eine Vorschiffkabine, eine geräumige Achterkabine steuerbord und einen großen Stauraum backbord, den Sie als Segellast oder für sonstige Bordausrüstung nutzen können.

The standard Dehler 34 has a front cabin, a spacious aft cabin starboard and a large storage room portside, which can be used for board equipment or as a sail locker.

DEHLER UNI DOOR CONCEPT

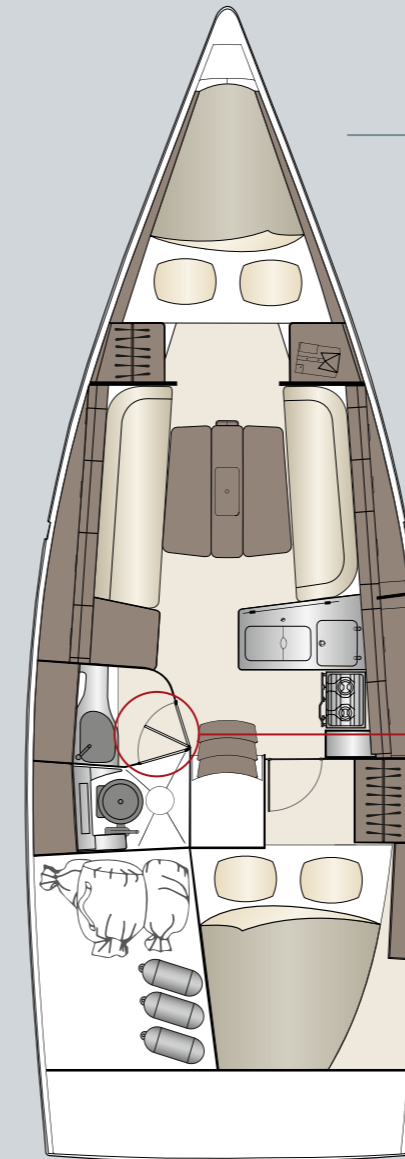

STANDARD

- A1** Forward cabin with open bulkhead
- A4** Light weight cabinets (not illustrated)
- B1** Saloon with longitudinal sofa and chart table on port, head with **Dehler Uni Door Concept**
- C1** 1 aft cabin with double berth

OPTION

- Large owner's cabin with **double berth** **A2**
- Light weight cabinets (not illustrated) **A3**
- Saloon with longitudinal sofa and chart table on port, head with **Dehler Uni Door Concept** **B1**
- 1 aft cabin with double berth **C1**
- Light weight cabinets (not illustrated) **C3**

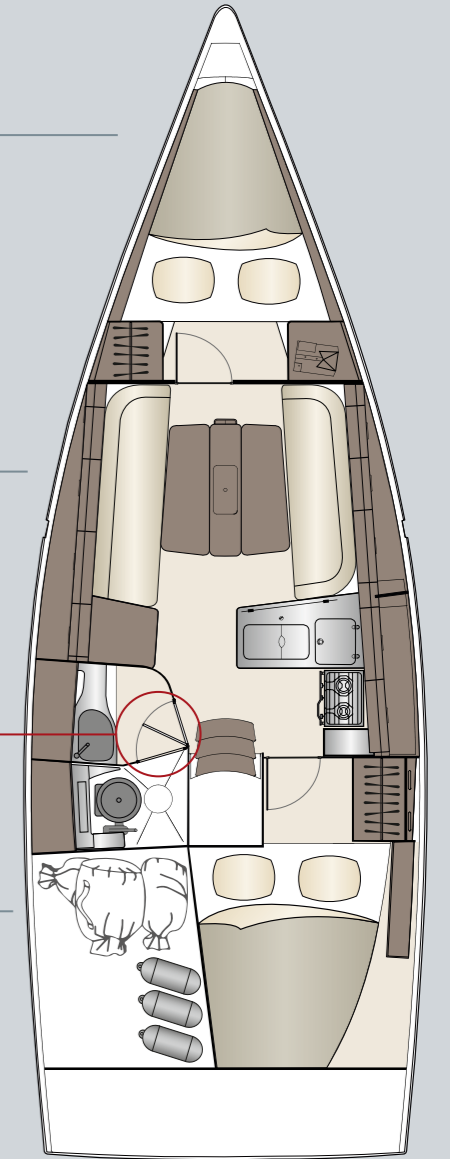



INTERIOR

MATERIALS & COLOURS

Selbstverständlich bieten wir Ihnen auch Gestaltungs-Varianten für die Fußböden, das Holz der Möbel, die Arbeitsplatte in der Pantry und für die Polster. Gestalten Sie die Dehler 34 nach Ihrem Geschmack.

It goes without saying that we also offer you a variety of designs for the floorings, furniture wood, worktop in the galley and for the upholstery. Design the Dehler 34 to your own preferences.

INTERIOR | UPHOLSTERY BALTIC

Mix and match as you wish.

All upholstery can be matched with the following piping colours: gold, silver, red, blue and black.

STANDARD

cream / gold piping



cream / blue piping



cream / red piping



cream / black piping



cream / silver piping



INTERIOR | UPHOLSTERY ARCTIC

Mix and match as you wish.

All upholstery can be matched with the following piping colours: blue, red, black, silver and gold.

OPTIONS

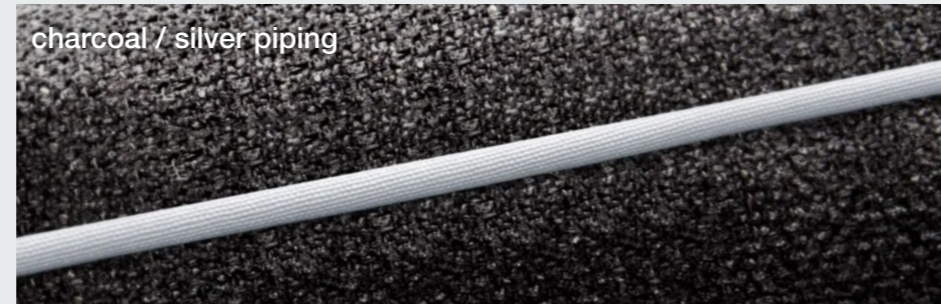

INTERIOR | UPHOLSTERY PACIFIC

Mix and match as you wish.

All upholstery can be matched with the following piping colours: blue, red, black, silver and gold.

OPTIONS

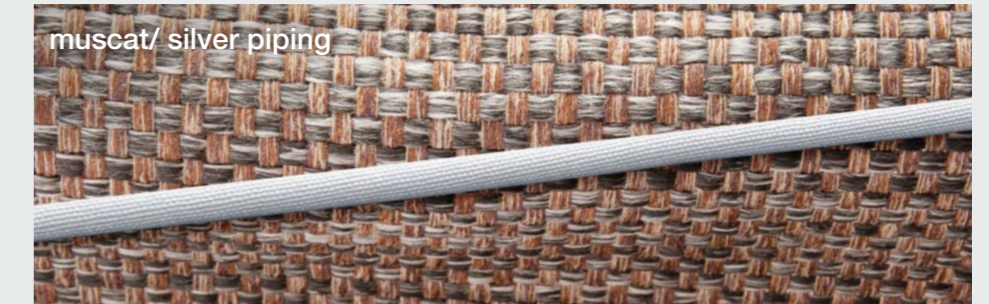

INTERIOR | UPHOLSTERY ADRIATIC LEATHER

Mix and match as you wish.

All upholstery can be matched with the following piping colours: blue, red, black, silver and gold.

OPTIONS

ivory / blue piping



clay / red piping



mud / black piping



chocolate / silver piping

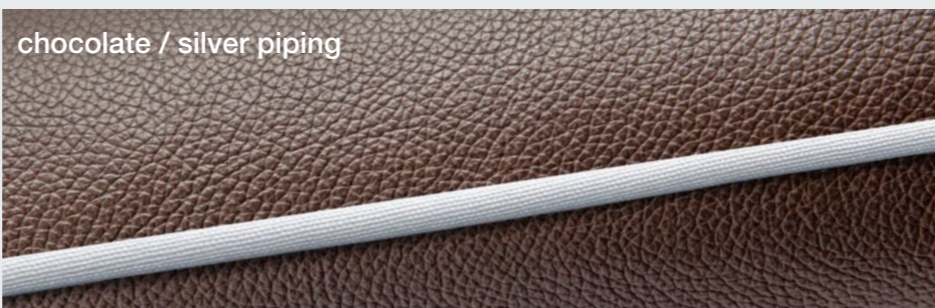

basalt / gold piping



INTERIOR | SURFACES

Worktop Galley

STANDARD

white

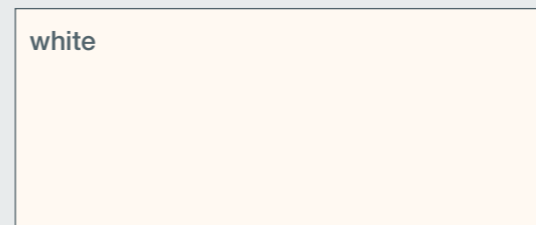

OPTIONS

black

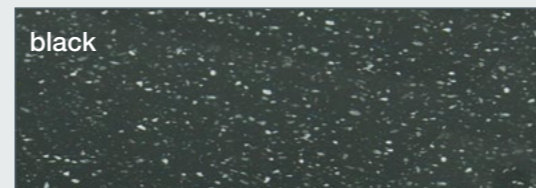

Furniture Wood

STANDARD

mahogany

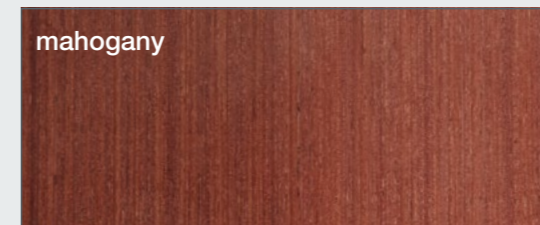

OPTIONS

teak

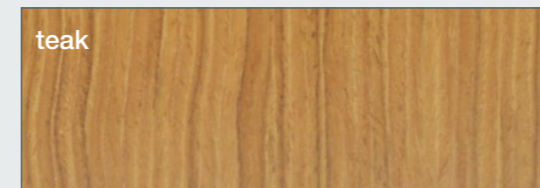

oak

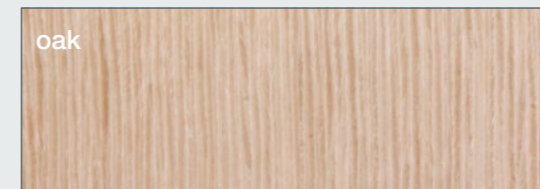

Floorboards

STANDARD

australian acacia

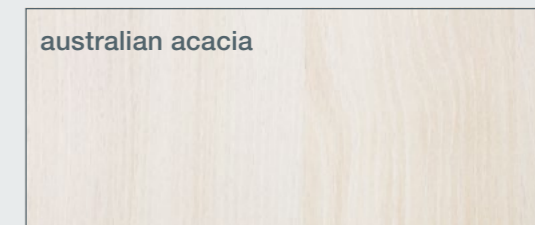

OPTIONS

noce nero

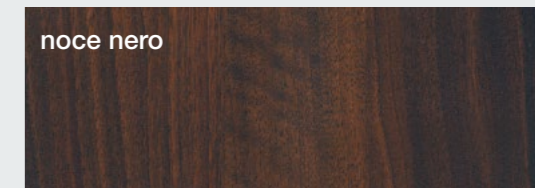

classic stripes

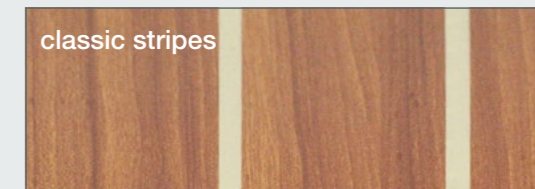

piave oak





TECHNOLOGY

DEEPER INSIDE

Die Dehler 34 ist durchdacht und perfektioniert bis ins letzte Detail. Sie wird mit der führenden 3D-Software CATIA entworfen, die auch im Flugzeugbau zum Einsatz kommt. Bestens geschulte Ingenieure gehen in einer virtuellen Yacht ans Werk: Sie teilen Räume intelligent auf, verleihen den Einbauten ausgefallene Formen, erfinden neue Technik – und verwandeln damit die Gesetze der Physik in ein herausragendes Segel-Erlebnis.

The Dehler 34 is well thought-out and perfected down to the last detail. It is designed with the leading 3D software CATIA, which is also used for aircraft development. Working in a virtual yacht, the most qualified engineers divide spaces in a smart way, create extraordinary furniture shapes, invent new techniques – and doing so, they turn the laws of physics into an unrivalled sailing experience.

3D THINKING CREATES SPACE

DEHLER UNI DOOR CONCEPT

The Dehler Uni Door Concept allows the use of two cabins at the same time. The door is hinged in a position that will either separate the head from the bathroom or close to the adjacent cabin to extend the space of the bath. Smart perfection!

FULL SANDWICH HULL

The sandwich construction allows to make the hull thicker and lighter at the same time. In addition, it insulates against severe cold or heat.

- Sealing: saltwater-resistant gelcoat
- Core: Balsa Wood
- Outer skin: glass fibre laminated with vinylester resin

DOUBLE WHEEL STEERING OR TILLER STEERING

Choose the double wheel for the most comfortable helming or the tiller for fast manoeuvring.

DIESEL TANK (160 L)

- Perfect capacity for long-range cruising
- Optimum weight distribution due to central installation in transom
- Low centre of gravity increasing the righting moment

HULL WINDOWS

- Flush-mounted reducing drag when sailing
- More natural light inside the boat

BOW SPRIT

- Increases sailing performance with asymmetrical headsails
- Allows for increased gennaker surfaces thus increasing downwind performance
- Easier gybing due to increased space between sail and forestay
- Allows for headsails such as FREERIDE

FRESH WATER TANK (210 L)

- More storage space in saloon
- Improves weight distribution of the entire yacht

MAX BEAM SHROUDS

- High rigidity and stability: loads are directly distributed into hull structure
- No loss of tension or hull torsion hence increased performance
- Increased rig performance: wider spreaders result in a stiffer rig

KEEL STEPPED MAST

- Leads forces directly into the carbon cage
- Increases rigidity, minimises deck pressure
- Weighs less than a deck stepped mast
- Easier to trim, more seaworthy and secure

ENGINE

- placed in a space saving manner
- easily accessible
- sound-insulated housing
- sufficient space for larger engines
- folding propeller as standard

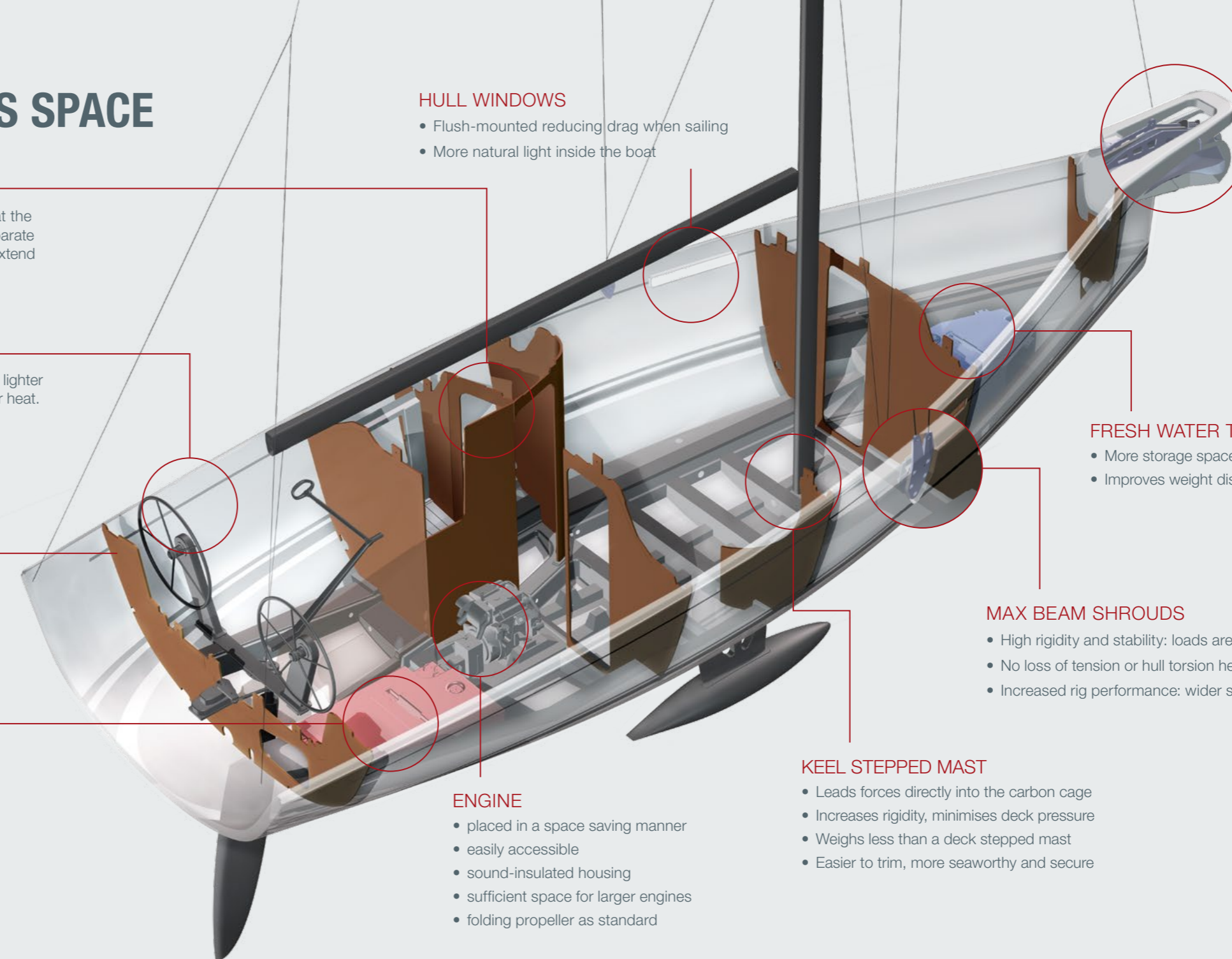

HIGH-PRECISION MILLING

A PERFECT YACHT BEGINS WITH A PERFECT SHAPE

Building the mould marks a crucial step when creating a new Dehler. So we focus – as we do at any stage of the manufacturing process – on leading-edge technologies and use computer driven milling systems.

- Hulls and superstructures are cut by a 20-metre-long MAKI CNC milling machine. It creates forms that are perfectly symmetrical and remarkably consistent.
- To generate smaller shapes like our ergonomic plotter pods, Dehler uses a KUKA milling robot. It works with an accuracy of 0.4 millimetres and fits perfectly with our idea of quality.



KEEL TYPES

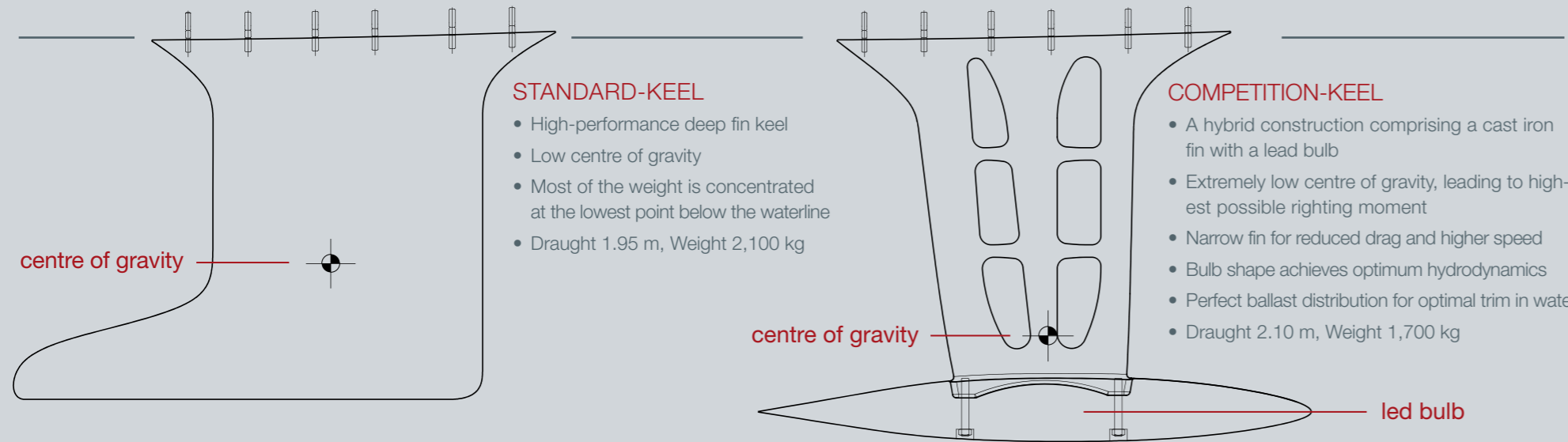

DEHLER CARBON CAGE

A rigid floor structure is the secret in strong and well performing hulls. Being the backbone of the yacht, it directly affects the sailing performance. That is why the Dehler Carbon Cage comes as standard with the Dehler 34.

HOW IT WORKS

The floor structure is reinforced with carbon fibre at thoughtfully selected points.

LESS TORSION

The torsion of hull is minimised under high rig loads and in high seas, so it better withstands the forces of water and wind.

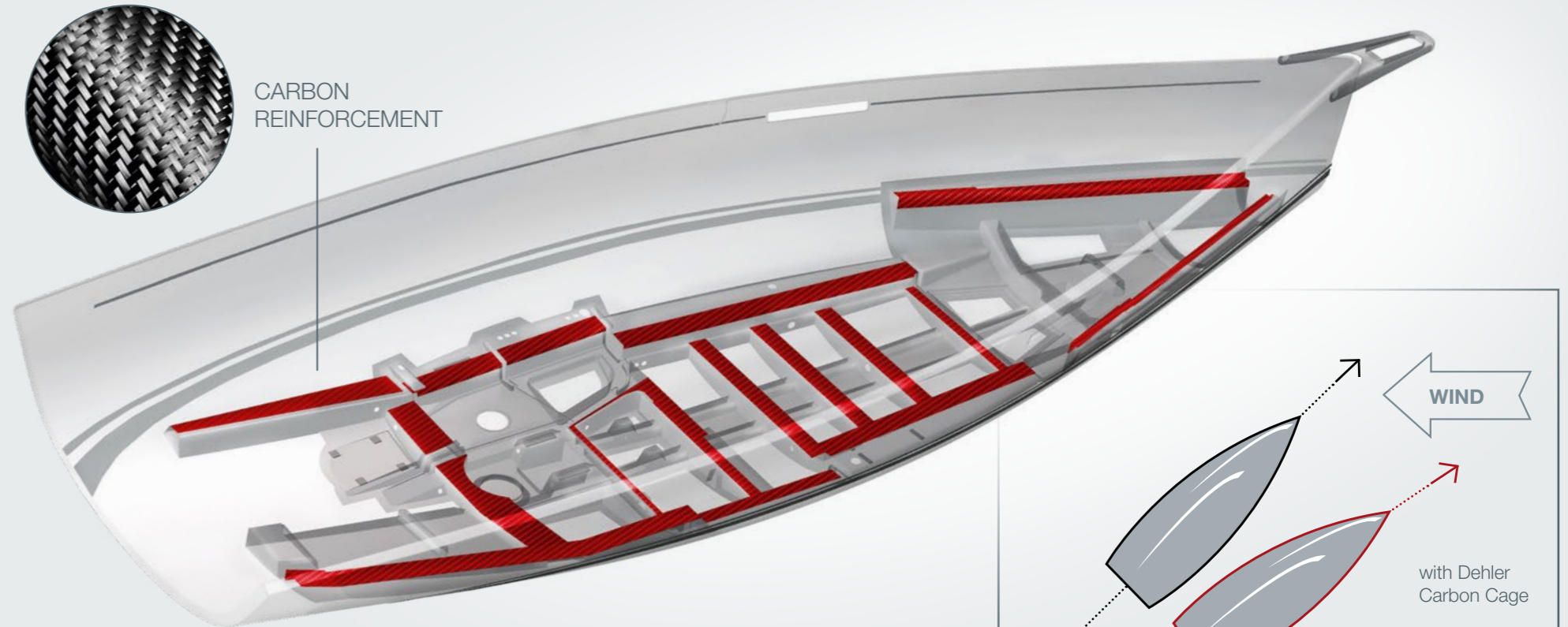

A NEW LEVEL OF STABILITY

The rigidity of the mast base is increased by 50%; the inner grid is 25% stronger.

HIGHER LONGEVITY

A hull less stressed lasts longer and extends the life span of your yacht.

CLOSER TO THE WIND

The Dehler Carbon Cage benefits not only ambitious sailors, it also increases the general sailing fun onboard.

TECHNOLOGY

MYDEHLER SAFETY CLOUD

YOUR ENTIRE YACHT IN YOUR HAND

Alle sprechen von der digitalen Zukunft, doch Dehler setzt sie um – mit dem ersten cloudbasierten Telematiksystem für Serien-Segelyachten. Per Mobile App oder über den Bereich MYDEHLER SAFETY CLOUD auf dehler.com greifen Sie live auf alle relevanten technischen Daten und Funktionen zu.

Intelligente Funktionen wie BoatMonitoring, eLogbook und eServicebuch ermöglichen es Ihnen, ein automatisches Logbuch zu führen, alle Wartungstermine im Blick zu behalten und Ihre Yacht lückenlos zu überwachen.

Everyone is talking about the digital future. But Dehler is implementing it – with the first cloud-based telematics system for series production sailing yachts. You can access your boat's technical data and functions live via the mobile app or the MYDEHLER SAFETY CLOUD menu at dehler.com

Intelligent functions such as BoatMonitoring, eLogbook and eServicebook enable you to keep an automatic logbook, stay on top of all servicing dates and monitor your yacht seamlessly.

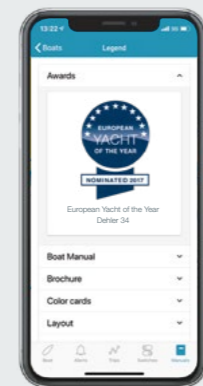

MANUALS

All manuals and instructions within one app.

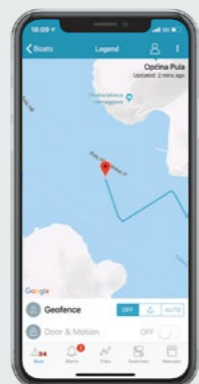

POSITION

Track your position in real time.

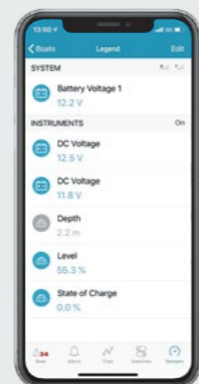

SENSORS

Monitor your charge levels and devices.

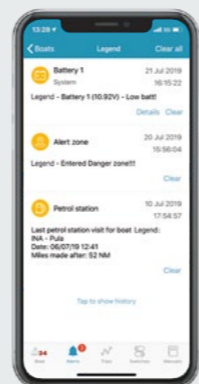

ALARMS

Push notifications on current events.

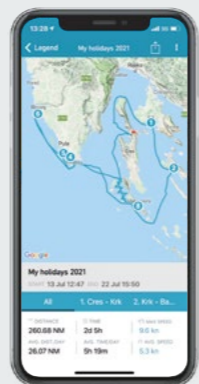

TRIP LOG

Share your cruises and track data with friends.

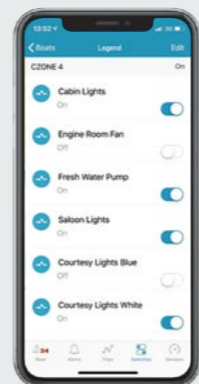

CONTROL

Operate your electronic devices by remote control.

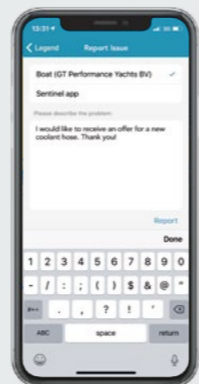

LIVE REPORT

Direct contact to your dealer for quick help.



- | | | | | | |
|---------------------------------------|------------------------------------|---|--|---|---|
| FRIDGE
Turn on/off remotely | LIGHTS
Turn on/off | HATCH/DOOR SENSOR
Monitor unauthorised access | SHORE POWER
Monitor connection | ENGINE
Monitor activity | MOTION SENSOR
Collision and grounding detection |
| FUEL TANK
Monitor level | WATER TANK
Monitor level | BATTERY BANK
Monitor level | GPS, WIND AND SPEED DATA | ANCHOR WINCH
Monitor activity | BOW THRUSTER
Monitor activity |
| | | | | BILGE PUMP
Monitor activity | |

*Control and sensors depend on the configuration of your Dehler.

Dehler 
34

OPTIONS

**AS YOU
 LIKE IT**

Mit den folgenden Ausstattungsoptionen können Sie genau definieren, wie komfortabel bzw. wie sportlich Ihre Dehler 34 sein soll. Um Ihnen die Wahl ein bisschen zu erleichtern, bieten wir Ihnen einige Extras in besonders attraktiven Paketen an.

The following furnishing options allow you to define precisely how comfortable or sporty your Dehler 34 should be. To make your choice a little easier, we offer some extras, conveniently bundled in packages.

PACKAGES

**COMPETITION –
 SETTING THE PACE**



PACKAGES

**NAVIGATION –
 SETTING THE COURSE**



PACKAGES

**ENTERTAINMENT UPGRADE –
 THE SOUND OF THE SEA**



RACE PLUS
6
 WINCHES



DVD ((SiriusXM)) EA2000 ETHERNET





Steering wheels Y-spoke design, colour black or white.



Cockpit upholstery.



2 winches LEWMAR 45 RACE.



Barber hauler with low friction ring.

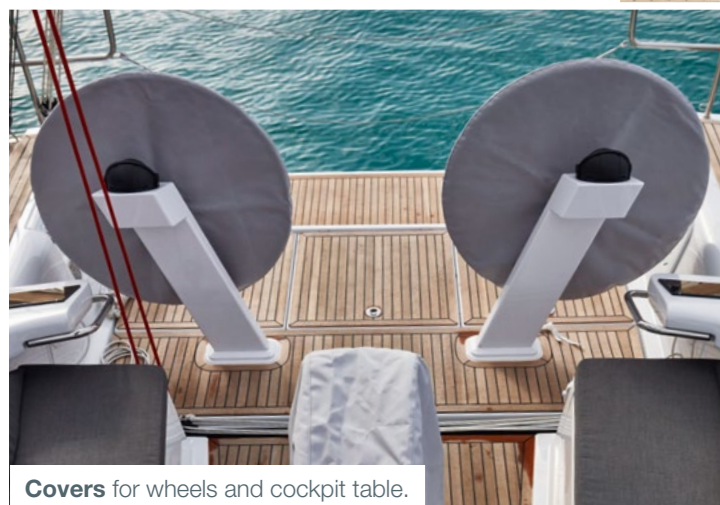

Covers for wheels and cockpit table.

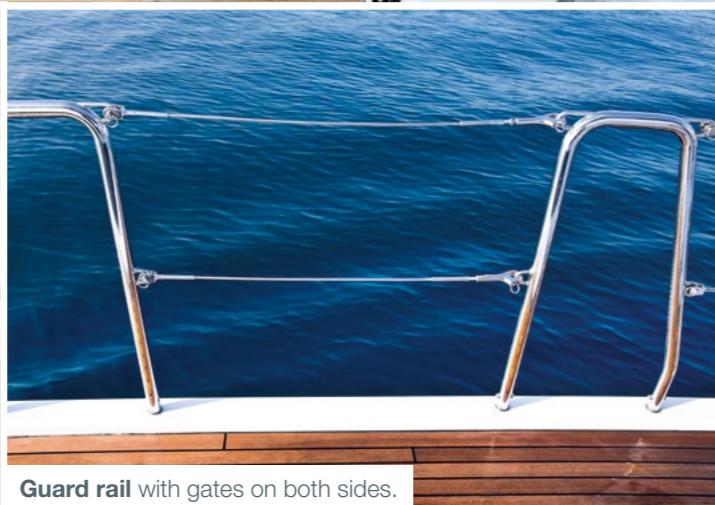

Guard rail with gates on both sides.



Cockpit table with retractable light.



Dehler FREERIDE.



Dehler Maindrop system with lazy bags, available in different colours.



Rub rail stainless steel.

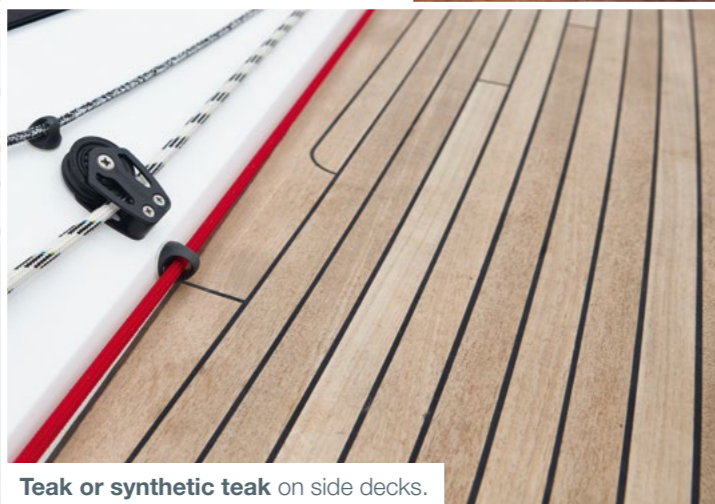

Teak or synthetic teak on side decks.



DELTA anchor incl. anchor fitting, 30 m chain.

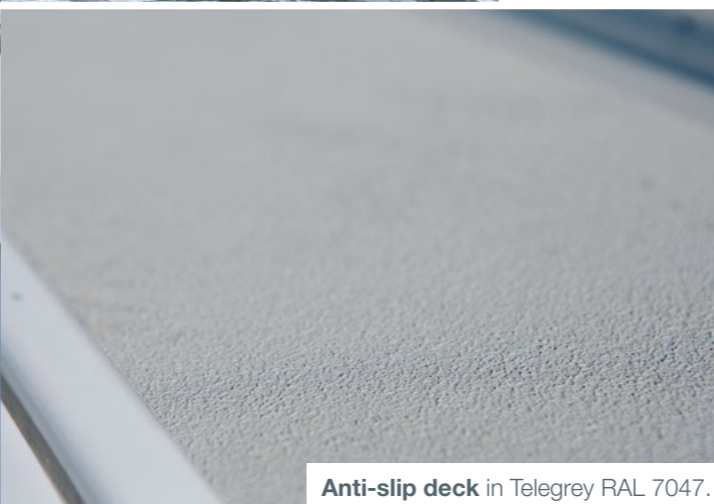

Anti-slip deck in Telegrey RAL 7047.



Composite bowsprit.



Electrical anchor windlass with remote control.





Dehler Yachts

Ladebower Chaussee 11

D-17493 Greifswald

www.dehler.com

Design: www.smz.de | Print: Eggers Druckerei & Verlag GmbH | Photos: Nico Krauss, Peter-Paul Reinmuth, HanseYachts AG. This brochure is not contractual. The yachts depicted partly comprise special equipment not included in the standard scope of supply. Illustrations may not correspond with current versions. Subject to alterations in design and equipment without notice and errors excepted.

©2021 HanseYachts AG | CIBD34/F/0721